

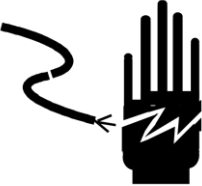



# User manual for LUW2001/LBW

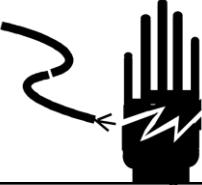

		<b>Warning</b>
<b>Ask professional personnel to debug, detect and repair controller.</b>		

		<b>Warning</b>
---	---	----------------

	<b>Warning</b>
---	----------------

**In electrical connection of controller, please cut off the power supply in advance. Wait for 30 seconds between power-on of the controller for 2 times.**

	<b>Pay Attention to Static Electricity</b>
---	--

**The controller is a device sensitive to static electricity, thus please take anti-static precautions in use and maintenance.**

# Contents

<b>I TECHNICAL INDICATORS.....</b>	<b>3</b>
<b>II MAIN FUNCTION.....</b>	<b>3</b>
<b>III BOUNDARY DIMENSION .....</b>	<b>3</b>
<b>IV INTRODUCTION TO PANEL.....</b>	<b>4</b>
<b>V. PARAMETER SETTING .....</b>	<b>6</b>
SETTING ENTRY: .....	6
PARAMETER SETTING OF F1 SCALE .....	6
<b>F2 APPLICATION FUNCTION SETTING.....</b>	<b>8</b>
<b>F3 ENERGY-SAVING PARAMETER SETTING.....</b>	<b>9</b>
<b>F4 SERIAL-PORT SETTING .....</b>	<b>9</b>
<b>F5 MAINTENANCE AND SERVICE .....</b>	<b>10</b>
<b>VI FUNCTION DESCRIPTION .....</b>	<b>11</b>
<b>APPENDIX 1. CONTINUOUS OUTPUT FORMAT SPECIFICATION .....</b>	<b>15</b>
<b>APPENDIX 2. PRINTING FORMAT SPECIFICATION .....</b>	<b>17</b>

## I Technical Indicators

- 6-digit 1.2-inch LED display, 7 state indicator lamps. Long service life and shock resistance
- 7 function keys. Operation is simple and convenient
- Protection level: IP5x
- Excitation voltage: +5VDC
- Load capacity of sensor: at most 4 350Ω simulation sensors
- Input signal range of null point: 0-5mV
- Input signal range of full scale: 1-10 mV
- Inner resolution: 1 million
- Weight upgrading rate: 40 times per second
- Power supply mode
  - Battery: 6V4Ah
  - Adapter: voltage 100-240VAC    Current 0.1A    Frequency 50-60Hz.
- 2 RS232 ports
- Operating temperature: -10°C-40°C, relative humidity is below 85 %
- Storage temperature: -20°C-60°C, relative humidity is below 85 %
- Conforming to standard: GB/T 7724-1999

## II Main Function

- Basic weighing function: resetting, removing the peel and clearing the peel
- Weight detection function, counting function, animal scale function
- Weight keeping function, weight accumulation function, percentage display
- Set redundant backup function of parameters
- Automatic screen protection and automatic shutdown energy-saving function
- Rich printing formats and communication protocol

## III Boundary Dimension

Instrument size: detailed in the following figure (mm); instrument weight:  
1.5kg

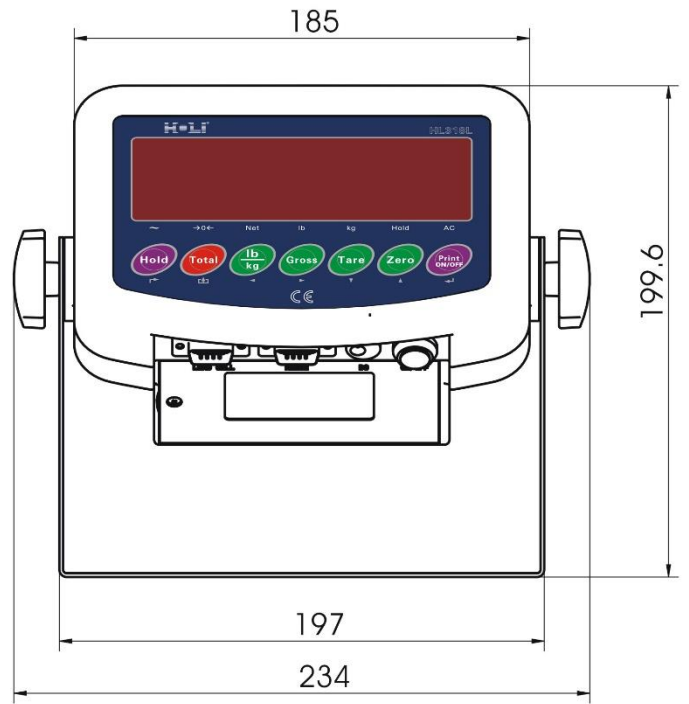
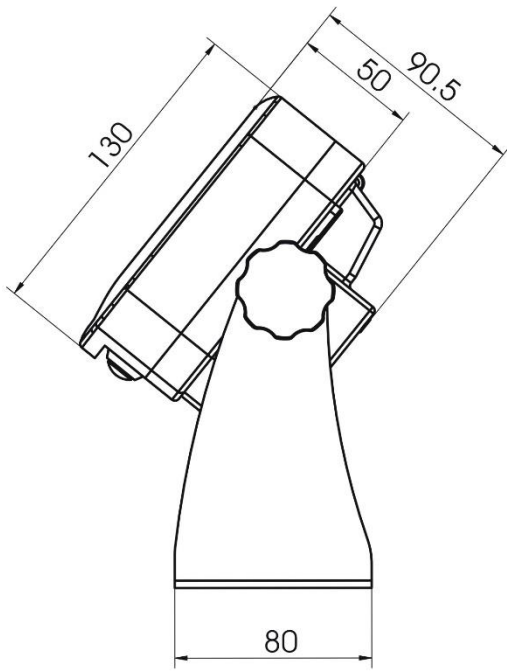

## IV Introduction to Panel





- Introduction to indicator lamps



Identifi cation	Analysis	Remark
~	Dynamic and static indication	The lamp is on when scale is in dynamic state, otherwise, the lamp is off
→0←	Zero center indication	The lamp is on when the absolute value of weight on the scale is less than $\pm 0.2d$ , otherwise the lamp is off
Net	Identification of gorses weight and net weight	The lamp is on in net weight and off in gross weight
lb	Weight unit	For indicating current unit
kg		
Hold	Weight maintenance	The lamp is on when the weight is locked, otherwise it is off

Ac	Voltage indication of battery and power supply	The green lamp is on when the voltage of the adapter and battery is normal, and the red lamp is on in undervoltage state
----	--	--

● Introduction to operation keys

Operation without special specification refers to short press on keys.

Key symbol	Normal weighing state	Set stage
	<p>Weight maintenance key</p> <p>Short press → F2.1 = 1, keep/cancel.</p> <p>F2.1 = 2, switch between percentage and weight.</p> <p>F2.1 = 5, switch between quantity and weight.</p> <p>Long key → enter setting menu.</p>	Return to the last menu.
	<p>Accumulation key</p> <p>Short key → F2.1 = 4, include display weight in accumulation value.</p> <p>Long key → F2.1 = 3, select scale to sample target weight.</p> <p>F2.1 = 4, accumulate weight of scale display.</p> <p>F2.1 = 5, count sampling of scale.</p>	No definition.
	<p>Unit conversion key</p> <p>Short key → in weighing state, switch weight unit. The corresponding unit indication lamp is on.</p>	Flicker bit is on the left.
	<p>Skin removal key</p> <p>Short key → net weight turns to gross weight; induction lamp of net weight “Net” is off.</p>	Flicker bit is on the right.
	<p>Skin removal key</p> <p>Short key → gross weight turns to net weight. Indication lamp of net weight “Net” is on. Conduct skin removal operation for multiple times.</p>	Digit flicker position reduces.

	<p>Zero clearing key</p> <p>Gross weight state resets weight. When the scale is in net weight, dynamic state, saving state and out of resetting range, zero clearing operation is invalid.</p>	<p>In setting, digit of flicker position increases. In adjustment of display, accumulation is cleared.</p>
	<p>Printing key</p> <p>Short key → start up or print.</p> <p>Printing format refers to <i>Appendix1</i>.</p> <p>Long key → shut down.</p>	<p>Confirm operation, to save setting data.</p>

## V. Parameter Setting

### Setting entry:

Press the [Hold] button on the operating panel in the state of normal weighing.

If F1.14 = 0, you can set all the parameters within F1~F5.

If F1.14 = 1, you can only set all parameters within F2~F5.

If F1.14 = 1 and you need to set the parameters within F1 menu, you can press the calibration switch button until the F1 menu is entered.

### Parameter Setting of F1 Scale

#### F1.1 Measuring Range

Selectable parameters: 3~200000 (default value: 6)

#### F1.2 Decimal Places

Selectable parameters: 0 ---- no decimal point

0.0 ---- 1 decimal place

0.00 ---- 2 decimal places

0.000 ---- 3 decimal places (default

value)

0.0000 ---- 4 decimal places

#### F1.3 Number of Divisions

Selectable parameters: 1 (default value), 2, 5, 10, 20,

## F1.4 Calibration Unit

Selectable parameters: 0 ---- kg (default value)

1 ---- lb

## F1.5 Gravitational Acceleration

Selectable parameters: 9.70000 ~ 9.99999. Default value = 9.79455.

## F1.6 Null-point Calibration

**【E\_5CL】** Keeping empty the scale

Remove the weights on the weighing platform to guarantee the scale is in the empty state. Press the [Print] key and the meter will display [1 0 CAL]. The displayed digits will reduce slowly until the meter displays [00 CAL]. In the end it will display [End ] for one second, which indicates the end of null-point calibration.

## F1.7 Load-point Calibration

**【LOAD】** Loading weights

Load weights on the weighing platform to ensure that 10% of full-scale value  $\leq$  weight of weights  $\leq$  full-scale value, and then press the [Print] key to start the next step.

**【000000】** Entering the same weight value as that of the loaded weights.

Entering the same weight value as that of the loaded weights, please press the [Print] key after the scale becomes stable, and the meter will display [1 0 CAL]. After that, the displayed digits will reduce slowly until the meter displays [00 CAL]. In the end it will display [End ] for one second, which indicates the end of null-point calibration.

## F1.8 Automatic Null Tracking

Selectable parameters: OFF, 1 d, 2 d, 3 d (default value)

## F1.9 Automatic Reset Range at Startup

Selectable parameters: OFF, 2 %, 10 %, 20 % (default value)

## F1.10 Button Reset Range

Selectable parameters: OFF, 2 %, 10 % (default value), 20 %

## F1.11 Digital Filter



Selectable parameters: 0 ---- Mild Filtering

1 ---- Moderate Filtering (default value)

2 ---- Severe Filtering

F1.12 Steady Range

Selectable parameters: 1 d, 2 d, 3 d (default value)

F1.13 Overload Display Range

Selectable Parameters: 9d, 5% (default value), 10%, 20%

F1.14 F1 Menu Protection

operation  
Selectable Parameters: 0 ---- Enter F1 menu by keyboard

1 ---- Enter F1 menu by pressing the  
calibration button

F1.15 Restoring Factory Default

Set the parameters within F1~F4 as the defaults, which can't  
impact the parameters of standard scale.

## **F2 Application Function Setting**

F2.1 Function Selection

value)  
Selectable Parameters: 0 ---- Close the application functions (default

1 ---- Weight keeping function

2 ---- Percentage display function

function  
3 ---- Weight checking and sorting

4 ---- Accumulative scale function

5 ---- Counting scale function

6 ---- Animal scale function

F2.2 Empty-scale threshold value

Selectable Parameters: 0~ full range (default value: 0.001)

F2.3 Target Weight for Weight Checking and Sorting

Selectable Parameters: 0~ full range (default value: 2.000)

F2.4 Positive Error for Weight Checking and Sorting

Selectable Parameters: 0~ full range (default value: 0.100)

F2.5 Negative Error for Weight Checking and Sorting

Selectable Parameters: 0~ full range (default value: 0.100)

F2.6 Access to Target Weight for Weight Checking and Sorting, and Counting Sample Weight

Selectable Parameters: 0 ---- Access to Platform Weighing (default value)

1 ---- Manual Input Access

**F3 Energy-saving Parameter Setting**

F3.1 Time-out Screensaver Time Setting

Selectable Parameters: 0~ 99 minutes, (default value: 30 minutes)

If set to be 0, this function shall not be allowed.

During the screen protection, the display will randomly show “**■**”.

F3.2 Energy-saving Time Setting for Auto Power-off

Settable Parameters: 0~250 minutes. (default value: 150 minutes)

If set to be 0, this function shall not be allowed.

F3.3 Display Brightness Control

Selectable Parameters: 0---- low light level

1 ---- middle light level (default value)

2 ---- high light level

**F4 Serial-port Setting**

F4.1 Setting of UART0 Communication Interface Parameter

F4.1.1 Communication Mode

Selectable Parameters:

0 ---- no output (default value)

1 ---- continuous output protocol A

2 ---- continuous output protocol B

3 ---- continuous output MT

4 ---- firm output protocol A

5 ---- firm output protocol B

6 ---- key dispatch protocol A

7 ---- key dispatch protocol B

F4.1.2 Setting of Data and Check Pit

Selectable Parameters: 8\_N\_1 ---- 8-pit no parity check (default value)

7\_E\_1 ---- 7-pit odd parity check

7\_O\_1 ---- 7-pit even parity check

8\_E\_1 ---- 8-pit odd parity check

8\_O\_1 ---- 8-pit even parity check

#### F4.1.3 Baud Rate

Selectable Parameters: 1200, 2400, 4800, 9600 (default value)

#### F4.1.4 Continuous Output & Delivery Parity Check and Character (only for F4.1=3)

Selectable Parameters: 0 ---- no delivery (default value)

1 ---- delivery

#### F4.1.5 Bluetooth Node Setting (effective only when Bluetooth module option is configured)

Selectable Parameters: HoLi01~HoLi99 (default value: HoLi01)

### F4.2 Parameter Setting of UART1 Printing Interface

#### F4.2.1 Whether to connect the printer

Selectable Parameters: 0 ---- not connected to the miniprinter (default)

1 ---- connected to the miniprinter

#### F4.2.2 Printing Carriage Return Character

Selectable Parameters: 0~9 carriage return characters (default value: 3)

#### F4.2.3 Printing Setting of Accumulative Scale

Selectable Parameters: 0 ---- total accumulative data for printing (default value)

1 ---- printing detail + total accumulative data

## F5 Maintenance and Service

### F5.1 Key test

Instrument display **【PrESS】**, press 『Print』, 『Zero』, 『Tare』, 『Gross』, 『lb/kg』 and 『Total』 in order, and the instrument displays **【Print】**, **【Zero】**, **【TARE】**, **【Gross】**, **【Unit】**

and **【L0tAL】** , press 『Hold』 to quit key test.

#### F5.2 Display screen test

All strokes of meter display will have self-inspection, to observe whether there is lacks of strokes.

Press 『Hold』 or 『Print』 to quit test of display screen.

#### F5.3 Display current internal code

The display will show internal code of current instrument after smoothing. Press 『Hold』 or 『Print』 to quit the interface.

## VI Function Description

- Weight maintenance function F2.1 = 1

### Operation method

In normal weighing state, press 『Hold』 on the operation panel, the will instrument lock display weight of the current scale, and “Hold” indication lamp is on. Only when weight setting value  $\geq$  F2.2 is displayed, weight maintenance operation is effective. Otherwise, it will return to weighing state after invalid operation information **【--□□--】** is shown for a second.

If weight is in locked state, press 『Hold』 again to cancel locking of weight and return to normal weighing state, and “Hold” indication lamp is off.

If it is in weight locking state, refuse to remove skin, clear skin and zero setting operation.

- Percentage display F2.1 = 2

### Display specification

Display **【Pr 20.5】** , representing 20.5 %.

Pr = current actual weight / range  $\times$  100%.

Press 『Hold』 to display switch in percentage and weight.

- Check weight and selection scale function F2.1 = 3

### Function description

Set parameters such as F2.2 = A, F2.3 = B, F2.4 = C and F2.5 = D.

When display weight is X.

If  $X \leq A$ , do not conduct check weight and selection. 不

If  $X < (B - D)$ , it lacks of weight, and the display flickers.

If  $(B - D) \leq X \leq (B - C)$ , it is qualified and the display has normal display

If  $X > (B - C)$ , it is overweight and the display flickers.

#### Acquisition of target value

Press 『Total』 long until the display shows **【TARGET】**, and then press 『Print』 to show current target value and flicker.

If  $F2.6 = 0$ , press 『Print』, the instrument will take the weight on current scale as the new target value and quit the setting interface.

If  $F2.6 = 1$ , the display shows **【000000】**, to request manual change of target value. After change, press 『Print』 to save setting data and quit setting interface.

- Function of accumulation scale  $F2.1 = 4$

#### Operation method

In normal weighing state, when the scale is in zero, add weight to the scale and press 『Total』 on operation panel, if the display shows **【Add--】** progress bar, it indicates that the current display weight is included accumulated value, and then it returns to normal weighing state. If the display shows **【--00--】** for a second, and returns to the normal weighing state, it indicates operation is invalid. Reason: 1. Between two accumulation operations, the scale must have back-to-zero process, otherwise, accumulation is refused. 2. Accumulation operation is effective only when display weight  $\geq F2.2$  is set. 3. The scale is in dynamic state.

#### Adjustment, clearing and printing of accumulated value

In normal weighing state, press 『Total』 on operation panel for more than 2 seconds, the display will show **【TOTAL】** for a second, and then the display shows current total accumulated value **【R 9.500】** and flickers. To clear accumulated value, press 『Zero』, to make flicker weight be 0. Press 『Print』 to print accumulated data. Press 『Hold』 to quit the interface.

Attention: set whether to be over detailed data or accumulated data in F4.6.

● Function of counting scale F2.1 = 5

Instrument display

【c 128】, showing current quantity.

Sampling method

1. Check whether the scale is in zero, if not, press 『Zero』 for zero setting.
2. Place materials counted on the scale.
3. Press 『Total』 long until the display shows 【SAMPLE】, and then press 『Print』. If F2.6 = 0, the display shows 【PCS 00】. Input the quantity counted just now, and press 『Print』 for confirmation. The instrument saves sampling data and quits the sampling interface. If F2.6 = 1, the display shows 【0000000】, input sample weight. Press 『Print』, the instrument saves setting data and quits sampling setting interface.
4. In this function, press 『Hold』 to display switch between quantity and weight.

● Function of animal scale F2.1 = 6

Operation method

In normal weighing state, place the animal on the weighing platform and its weight must be  $\geq$  threshold value set in F2.2. Press 『Total』, instrument will collect data sampling. After sampling, the average value of sampling data will be locked, showing A X.XXX. Press 『Print』 to print; press 『Hold』 or 『Total』 to quit the interface.

● VII Prompt Message of Instrument

The instrument has extremely high stability and reliability, thus is not easy to 具有极 have error in general situation. Once an error occurs, please make clear the error first and observe whether the instrument still has error after power-on. Do not hurry to repair the scale body or instrument. Repair the instrument according to error code of the instrument as possible.

No.	Symbol	Analysis	Treatment Method
1	【 _EEE 】 【 EEE 】	Unable to reset after startup	1. Determine it is no-load state in startup; 2. Make zero calibration again.

2	【-----】	The weighed object is over full range for 9 days	Reduce weight on weighing platform
3	【L-----】	The weighed object is below 0 for 5 days	Press 『Zero』 to reset
4	【-----】 【L-----】	Out of zero clearing range	Check whether the weighing platform has weight. Remove weight.
5	【--Π--】	Invalid operation	
6	【Err 03】	EEPROM checksum and error	Press 『Print』 reprint factory value. Start up again. If the information occurs again, return to factory for repair. Please calibrate the scale again if the situation does not occur; <b>Attention:</b> this place is provided with all parameters of instruments of the factory.
7	【Err 05】	The calibration input weight is too small	Input $\geq$ 10 % weight of full range
8	【Err 06】	The weight in calibration is too light	Load $\geq$ 10% weight of full range
9	【Err 07】	The scale is dynamic in scale	Inspect the scale body
10	【Err 08】	Setting error of date and time	Set according to specification of date and time
11	【Err 09】	Error of AD initialization	If the error occurs after restarting, return it to the factory for repair
12	【LOAD】	In loading scale, it indicates to loading weight;	Load weight according to requirements;
13	【SETUP】	It has enters menu setting	Press 『Print』 to continue setting.
14	【End】	End of zero point and loading point calibration	
15	【Add--】	Including current display weight in accumulated value	
16	【-OVER-】	Accumulated weight	Clear accumulated weight in time

		overflows	
17	<b>【Ld---】</b>	Loading default value	
18	<b>【Print】</b>	Printing	

## Appendix 1. Continuous Output Format Specification

### 1. Continuous output MT format

Continuous output MT format has 18 digits.

Continuous output format																	
ST	A	B	C	X	X	X	X	X	X	X	X	X	X	X	X	C	CK
X															R	S	
1	3			6						6						1	1

Where

1. <STX> ASCII (02H)
2. Status word: A, B, C
3. Display weight, possibly gross weight or net weight, 6 digits without symbol or decimal point.
4. Tare weight, 6 digits without symbol or decimal point
5. <CR> ASCII carriage return (ODH)
6. <CKS> optional checksum and (no output in F4.2.3 = 0)

Status word: A, B, C.

Status word A			
Bit 0	Bit 1	Bit 2	Position of decimal point
0	1	0	XXXXXX
1	1	0	XXXXX.X
0	0	1	XXXX.XX
1	0	1	XXX.XXX
0	1	1	XX.XXXX
Bit 3	Constant 0		
Bit 4	Constant 1		
Bit 5	Constant 0		
Bit 6	Constant 1		
Bit 7	Constant 0/check bit		



Status word B	
Bits	Function
Bit 0	Gross weight = 0, net weight = 1
Bit 1	Symbol: positive = 0, negative = 1
Bit 2	Overload (upper and lower overload) = 1
Bit 3	Static = 0, dynamic = 1
Bit 4	Constant 1
Bit 5	Constant 1
Bit 6	Constant 0
Bit 7	Constant 0/check bit
Status word C	
Bits	Function
Bit 0	Unit: kg = 0, lb = 1
Bit 1	Constant 0
Bit 2	Constant 0
Bit 3	Constant 0
Bit 4	Constant 1
Bit 5	Constant 1
Bit 6	Constant 0
Bit 7	Constant 0/check bit

## 2. Continuous output A format

The data transmitted by continuous output protocol A is present display weight.

Gross weight format: ww0000.000kg or ww0000.000lb

Net weight format: wn0000.000kg or wn0000.000lb

Example: gross weight of 15.000kg

w	w	0	0	0	1	5	.	0	0	0	k	g	0	d	0a
---	---	---	---	---	---	---	---	---	---	---	---	---	---	---	----

Net weight of 15.000kg

w	n	0	0	0	1	5	.	0	0	0	k	g	0	d	0a
---	---	---	---	---	---	---	---	---	---	---	---	---	---	---	----

Gross weight-15.000kg

w	w	-	0	0	1	5	.	0	0	0	k	g	0	d	0a
---	---	---	---	---	---	---	---	---	---	---	---	---	---	---	----

Note: the above position of the decimal point is determined according to that in the instrument.

### 3. Continuous output B format

Continuous output agreement B format:

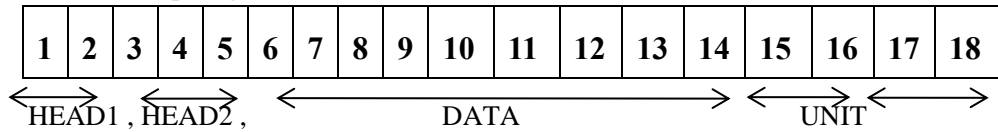

CR/LF

HEAD1: OL Upper overload or lower overload, or no zero clearing in startup;

ST the scale is in stable state;

US the scale is in unstable state;

HEAD2: GS gross weight;

NT net weight;

DATA: instrument display data;

UNIT: kg or lb;

CR/LF: new line.

Example 1: in stable state, gross weight is 18.000kg. sp = space.

S	T	,	G	S	,	sp	sp	1	8	.	0	0	0	k	g	0	0a
---	---	---	---	---	---	----	----	---	---	---	---	---	---	---	---	---	----

Example 2: in unstable state, net weight is -0.200kg. sp = space.

U	S	,	N	T	,	-	sp	sp	0	.	2	0	0	k	g	0	0a
---	---	---	---	---	---	---	----	----	---	---	---	---	---	---	---	---	----

## Appendix 2. Printing Format Specification

F2.1 = 0, 1, 4, 6, print current resetting, press 『Print』 .

REPORT	
-----	
Gross	0.200kg
Tare	0.000kg
Net	0.200kg

F2.1 = 1 weight maintenance function:

Weight is not in maintenance state:

REPORT	
-----	
Gross	0.200kg
Tare	0.000kg
Net	0.200kg

Weight is in maintenance state:

REPORT	
-----	
Gross	25.000kg
Status	Hold

or

REPORT	
-----	
Net	25.000kg
Status	Hold

F2.1 = 3 selection, check weight, press 『Print』 :

REPORT	
-----	
Gross	1.980kg
State	Less

Underweight

REPORT	
-----	
Gross	2.000kg
State	OK

Qualified

REPORT	
-----	
Gross	2.020kg
State	Over

Overweight

F2.1 = 4 accumulation scale, print detailed statement or format of total weight:

Print details and total weight

REPORT	
-----	
1	0.200kg
2	0.175kg
3	0.347kg
4	0.375kg
-----	
Total	1.097kg

Only print total weight

REPORT	
-----	
Total	1.097kg

F2.1 = 5 counting scale, press 『Print』 :

REPORT	
-----	
Gross	0.547kg
Amount	55